

FICHE TECHNIQUE

Panel Line Light

Modèle PLL5DA5061D2D35B

Panel Line Light 28W 3160Lm H41*L600*I600mm Plafond suspendu IP40 IK08 90° 4000K

Code GTIN : 3701481506223



Fabriqué en Europe



Sur commande



Sur-mesure possible

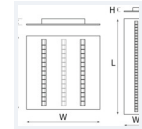
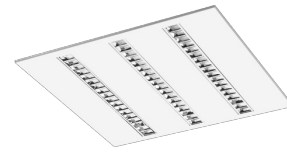

Photo(s) non contractuelle(s).
L'apparence du produit peut être amenée à être modifiée.

Informations principales

Réf.	PLL5DA5061D2D35B
Marque	PIXEL Lighting
Nom produit	Panel Line Light
Type	Éclairage intérieur
Catégorie	Panel
Sous-catégorie	Line
Application(s)	Bâtiment tertiaire, Etablissement scolaire
Variante(s)	6 variantes
Coloris	Blanc
Dimensions	H41 * L600 * I600 mm
Dimensions d'installation	H41*L596*I596mm
Poids	5000g

Données techniques

Puissance	28 W
Flux lumineux	3160 LM
Rendement	112 LM/W
Angle de diffusion	90°
Température de couleur	4000K
Type de montage	Plafond suspendu
Type de LED	SMD5630
Type de diffuseur / réflecteur	Parabolique
Type de driver	Osram Optotronic
Usage intensif	Oui
Température fonctionnement	-15° à +40° C

Normes

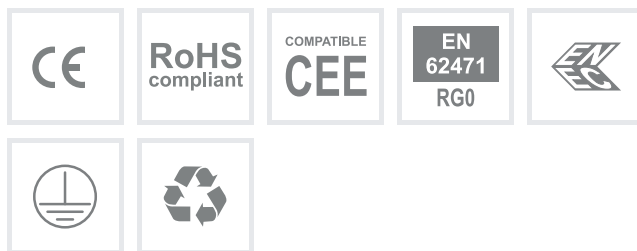

Performances luminaire



Caractéristiques



En option



Variantes

Réf.	Puissance en W	Flux lumineux en LM	Rendement en LM/W	Angle en °	Dimensions en mm	Type de montage	Température couleur en K	IP	IK	Durée de vie en H	L / B	Classe
PLL5DA5061D2614F	28	3100	110	90°	H41 * L600 * l600	Plafond suspendu	3000K	40	08	72000	L80B10	I
PLL5DA5061D34DC6	28	3100	110	90°	H41 * L1200 * l300	Plafond suspendu	3000K	40	08	72000	L80B10	I
PLL5DA5061D2D35B	28	3160	112	90°	H41 * L600 * l600	Plafond suspendu	4000K	40	08	72000	L80B10	I
PLL5DA5061D3B6AA	28	3160	112	90°	H41 * L1200 * l300	Plafond suspendu	4000K	40	08	72000	L80B10	I
PLL5DA5061CC348A	42	4660	110	90°	H41 * L600 * l600	Plafond suspendu	3000K	40	08	72000	L80B10	I
PLL5DA5061D1F4BD	42	4760	113	90°	H41 * L600 * l600	Plafond suspendu	4000K	40	08	72000	L80B10	I

Accessoires

Aperçu	Réf.	Nom	Description	Garantie (an)	Marque
	ACC5DC3515FE48E7	Driver DALI 10W-42 W 120-350 mA	Graduable DALI et 0-10V Durée de vie 60.000 heures	5	Helvar
	ACC619E489707A97	Cadre pour montage au plafond placo-plâtre 600*600	Encastrement 610*610 mm - Recouvrement 622*622 mm - Kit 4 fixations ressorts inclus	2	PIXEL Lighting

Schéma technique



Schéma de montage



Photos de mise en situation

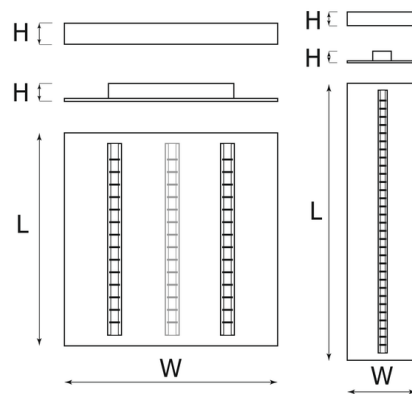
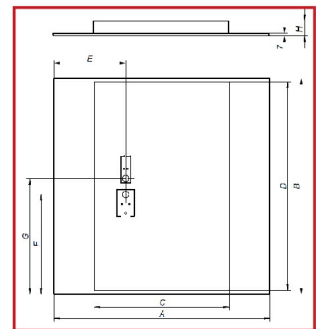
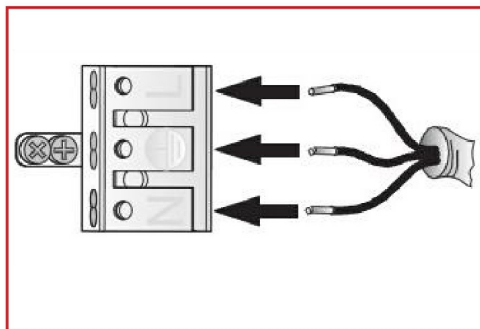
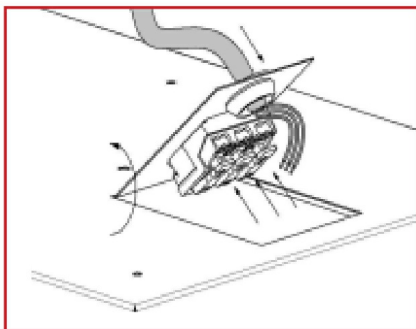