

# FICHE TECHNIQUE

## Suspension Novo-S Opale DI

Modèle SNSOD5DA5063254D7F

Suspension Novo-S Opale DI 14W 1340Lm H100\*L545\*I28mm Suspension IP20 IK08 120° 4000K

Code GTIN : 3701481501365



Fabriqué en Europe



Sur commande



Sur-mesure possible

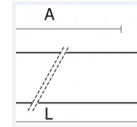
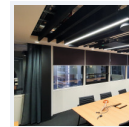
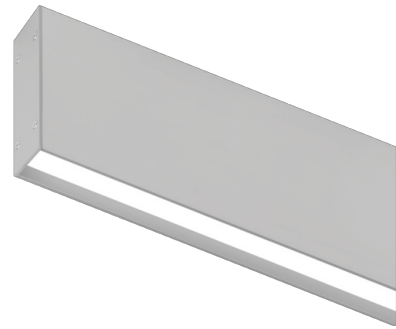

Photo(s) non contractuelle(s).  
L'apparence du produit peut être amenée à être modifiée.

### Informations principales

Réf.	SNSOD5DA5063254D7F
Marque	PIXEL Lighting
Nom produit	Suspension Novo-S Opale DI
Type	Éclairage intérieur
Catégorie	Suspension
Sous-catégorie	Novo-S
Application(s)	Bâtiment tertiaire
Variante(s)	8 variantes
Coloris	Gris, Noir, Blanc
Dimensions	H100 * L545 * I28 mm
Dimensions d'installation	-
Poids	1300g

### Données techniques

Puissance	14 W
Flux lumineux	1340 LM
Rendement	95 LM/W
Angle de diffusion	120°
Température de couleur	4000K
Type de montage	Suspension
Type de LED	SMD2835
Type de diffuseur / réflecteur	Opale
Type de driver	Helvar
Usage intensif	Non
Température fonctionnement	-20° à +40° C

### Normes

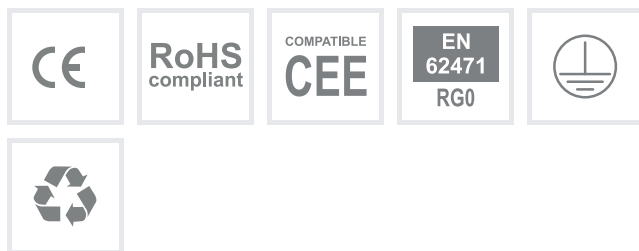

### Performances luminaire

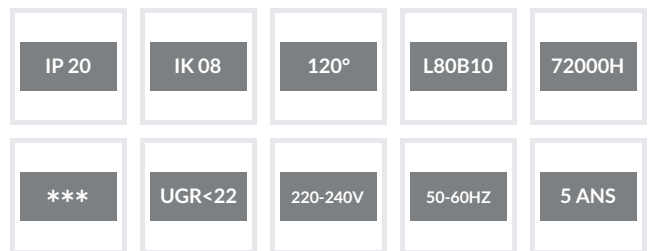

## Caractéristiques



## En option



## Variantes

Réf.	Puissance en W	Flux lumineux en LM	Rendement en LM/W	Angle en °	Dimensions en mm	Type de montage	Température couleur en K	IP	IK	Durée de vie en H	L / B	Classe
SNSOD5DA50631BF5A8	14	1320	94	120°	H100 * L545 * I28	Suspension	3000K	20	08	72000	L80B10	I
SNSOD5DA5063254D7F	14	1340	95	120°	H100 * L545 * I28	Suspension	4000K	20	08	72000	L80B10	I
SNSOD5DA506325E8FB	25	2630	105	120°	H100 * L1085 * I28	Suspension	3000K	20	08	72000	L80B10	I
SNSOD5DA5063267F6B	25	2690	107	120°	H100 * L1085 * I28	Suspension	4000K	20	08	72000	L80B10	I
SNSOD5DA5063270DB2	37	3950	106	120°	H100 * L1625 * I28	Suspension	3000K	20	08	72000	L80B10	I
SNSOD5DA5063279F2F	37	4030	108	120°	H100 * L1625 * I28	Suspension	4000K	20	08	72000	L80B10	I
SNSOD5DA506328333D	48	5260	109	120°	H100 * L2170 * I28	Suspension	3000K	20	08	72000	L80B10	I
SNSOD5DA506328D58B	48	5370	111	120°	H100 * L2170 * I28	Suspension	4000K	20	08	72000	L80B10	I

## Accessoires

Aperçu	Réf.	Nom	Description	Garantie (an)	Marque
	ACC5DC3515FE48E7	Driver DALI 10W-42 W 120-350 mA	Graduable DALI et 0-10V Durée de vie 60.000 heures	5	Helvar
	ACC5DC3516A97DF0	Driver DALI LL 1X10-42-E-DA 120-350mA	Graduable DALI, 0-10V Durée de vie : 60.000 heures	7	Helvar
	ACC5DC3516D15C84	Suspension Normale - Acier 1500 mm	Compatible gammes : Start - Novo - Nano - Record - Style - Initial - Micro - Ring - Geo - Linéa - Retail - Dimensions : 1500 mm x 15/12 mm	2	PIXEL Lighting
	ACC5DC3516DC3A58	Suspension Electrique - Gris Clair 1500 mm	Compatible gammes : Start - Novo - Nano - Record - Style - Initial - Micro - Ring - Geo - Retail - Alimentation électrique incluse	2	PIXEL Lighting
	ACC5DC3516ECF6B9	Suspension Electrique - Blanc 1500 mm	Compatible gammes : Start - Novo - Nano - Record - Style - Micro - Ring - Geo - Retail - Alimentation électrique incluse	2	PIXEL Lighting
	ACC5DC351707185D	Suspension Electrique - Noir 1500 mm	Compatible gammes : Start - Novo - Nano - Record - Style - Geo - Ring Alimentation électrique incluse	2	PIXEL Lighting

Aperçu	Réf.	Nom	Description	Garantie (an)	Marque
	ACC5DC35179201C1	Jonction linéaire invisible Aluminium	Fixation de 2 modules entre eux Compatible gamme Novo-S	2	PIXEL Lighting
	ACC5F4E50E4D08F5	Câblage traversant 5 fils - 545 mm	Compatible gamme Novo	5	PIXEL Lighting
	ACC5F4E514711D7F	Câblage traversant 5 fils - 1085 mm	Compatible gamme Novo	5	PIXEL Lighting
	ACC5F4E51F2E7A20	Câblage traversant 5 fils - 1625 mm	Compatible gamme Novo	5	PIXEL Lighting
	ACC5F4E5237BB748	Câblage traversant 5 fils - 2170 mm	Compatible gamme Novo	5	PIXEL Lighting
	ACC61A5F0C2D3FC2	Capot de fin de ligne noir	Aluminium - Couleur Noire - Visserie noire incluse	2	PIXEL Lighting
	ACC61A5F23653EAE	Capot de fin de ligne gris	Aluminium - Coloris gris	2	PIXEL Lighting

## Schéma technique et de montage

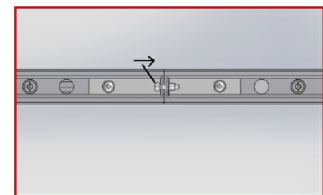
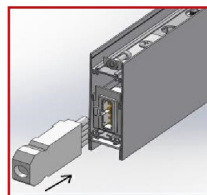
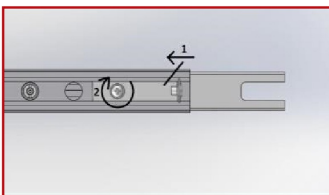
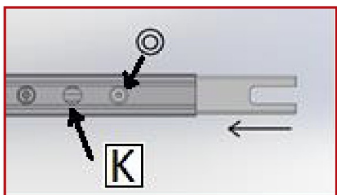
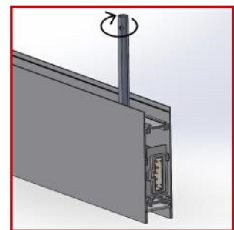
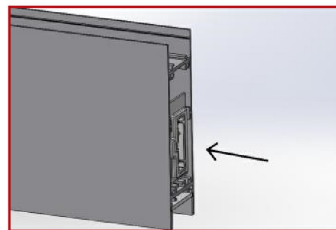
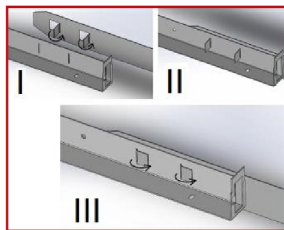
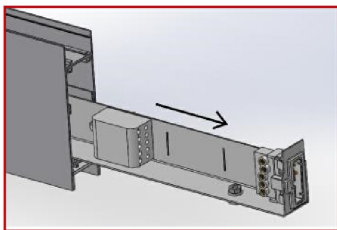
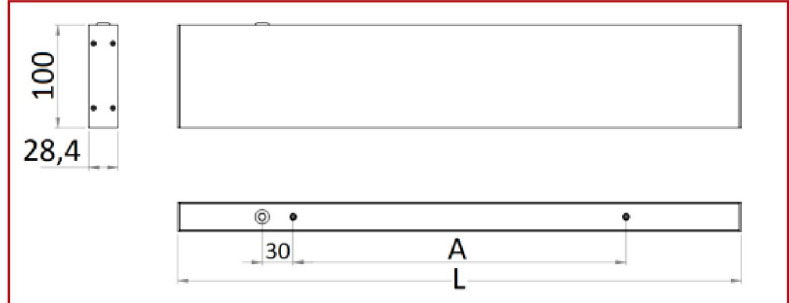
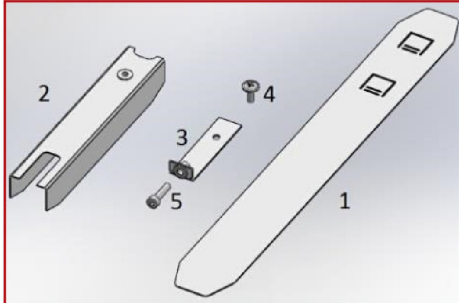

## Système de suspension rapide

