

FICHE TECHNIQUE

Suspension Novo-S Parabolique DI

Modèle SNSPD5DA50635CA3B6

Suspension Novo-S Parabolique DI 40W 4210Lm H100*L2170*I28mm
Suspension IP20 IK08 90° 3000K

Code GTIN : 3701481501174

Fabriqué en
Europe

Sur commande

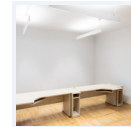
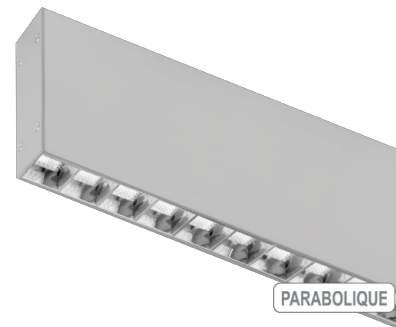
Sur-mesure
possiblePhoto(s) non contractuelle(s).
L'apparence du produit peut être amenée à être modifiée.

Informations principales

Réf.	SNSPD5DA50635CA3B6
Marque	PIXEL Lighting
Nom produit	Suspension Novo-S Parabolique DI
Type	Éclairage intérieur
Catégorie	Suspension
Sous-catégorie	Novo-S
Application(s)	Bâtiment tertiaire
Variante(s)	8 variantes
Coloris	Gris, Noir, Blanc
Dimensions	H100 * L2170 * I28 mm
Dimensions d'installation	-
Poids	4500g

Données techniques

Puissance	40 W
Flux lumineux	4210 LM
Rendement	105 LM/W
Angle de diffusion	90°
Température de couleur	3000K
Type de montage	Suspension
Type de LED	SMD2835
Type de diffuseur / réflecteur	Parabolique
Type de driver	Helvar
Usage intensif	Non
Température fonctionnement	-20° à +40° C

Normes



Performances luminaire

IP 20	IK 08	90°	L80B10	72000H
***	UGR < 21	220-240V	50-60HZ	5 ANS

Caractéristiques



En option



Variantes

Réf.	Puissance en W	Flux lumineux en LM	Rendement en LM/W	Angle en °	Dimensions en mm	Type de montage	Température couleur en K	IP	IK	Durée de vie en H	L / B	Classe
SNSPD5DA5063509AD9	12	1050	87	90°	H100 * L545 * I28	Suspension	3000K	20	08	72000	L80B10	I
SNSPD5DA506359638E	12	1080	90	90°	H100 * L545 * I28	Suspension	4000K	20	08	72000	L80B10	I
SNSPD5DA50635A1A1F	21	2110	100	90°	H100 * L1085 * I28	Suspension	3000K	20	08	72000	L80B10	I
SNSPD5DA50635AAE52	21	2150	102	90°	H100 * L1085 * I28	Suspension	4000K	20	08	72000	L80B10	I
SNSPD5DA50635B5C46	30	3160	105	90°	H100 * L1625 * I28	Suspension	3000K	20	08	72000	L80B10	I
SNSPD5DA50635C025F	30	3230	107	90°	H100 * L1625 * I28	Suspension	4000K	20	08	72000	L80B10	I
SNSPD5DA50635CA3B6	40	4210	105	90°	H100 * L2170 * I28	Suspension	3000K	20	08	72000	L80B10	I
SNSPD5DA50635D47B4	40	4300	107	90°	H100 * L2170 * I28	Suspension	4000K	20	08	72000	L80B10	I

Accessoires

Aperçu	Réf.	Nom	Description	Garantie (an)	Marque
	ACC5DC3515FE48E7	Driver DALI 10W-42 W 120-350 mA	Graduable DALI et 0-10V Durée de vie 60.000 heures	5	Helvar
	ACC5DC3516D15C84	Suspension Normale - Acier 1500 mm	Compatible gammes : Start - Novo - Nano - Record - Style - Initial - Micro - Ring - Geo - Linéa - Retail - Dimensions : 1500 mm x 15/12 mm	2	PIXEL Lighting
	ACC5DC3516DC3A58	Suspension Electrique - Gris Clair 1500 mm	Compatible gammes : Start - Novo - Nano - Record - Style - Initial - Micro - Ring - Geo - Retail - Alimentation électrique incluse	2	PIXEL Lighting
	ACC5DC3516ECF6B9	Suspension Electrique - Blanc 1500 mm	Compatible gammes : Start - Novo - Nano - Record - Style - Micro - Ring - Geo - Retail - Alimentation électrique incluse	2	PIXEL Lighting
	ACC5DC351707185D	Suspension Electrique - Noir 1500 mm	Compatible gammes : Start - Novo - Nano - Record - Style - Geo - Ring Alimentation électrique incluse	2	PIXEL Lighting
	ACC5DC35179201C1	Jonction linéaire invisible Aluminium	Fixation de 2 modules entre eux Compatible gamme Novo-S	2	PIXEL Lighting





Aperçu	Réf.	Nom	Description	Garantie (an)	Marque
	ACC5F4E50E4D08F5	Câblage traversant 5 fils - 545 mm	Compatible gamme Novo	5	PIXEL Lighting
	ACC5F4E514711D7F	Câblage traversant 5 fils - 1085 mm	Compatible gamme Novo	5	PIXEL Lighting
	ACC5F4E51F2E7A20	Câblage traversant 5 fils - 1625 mm	Compatible gamme Novo	5	PIXEL Lighting
	ACC5F4E5237BB748	Câblage traversant 5 fils - 2170 mm	Compatible gamme Novo	5	PIXEL Lighting
	ACC61A5F0C2D3FC2	Capot de fin de ligne noir	Aluminium - Couleur Noire - Visserie noire incluse	2	PIXEL Lighting
	ACC61A5F23653EAE	Capot de fin de ligne gris	Aluminium - Coloris gris	2	PIXEL Lighting

Schéma technique et de montage



Système de suspension rapide

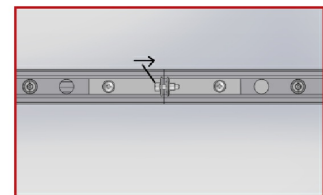
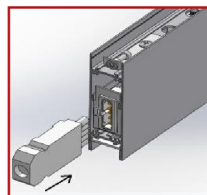
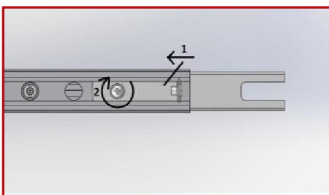
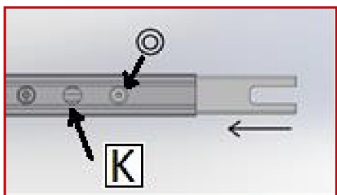
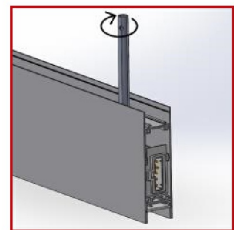
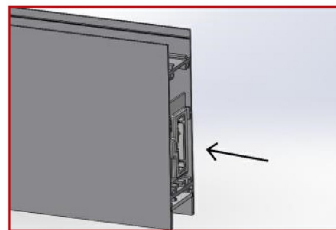
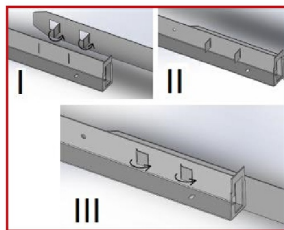
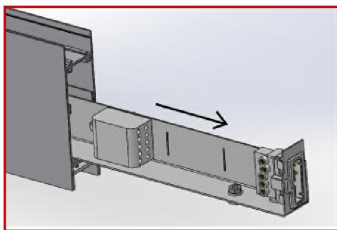
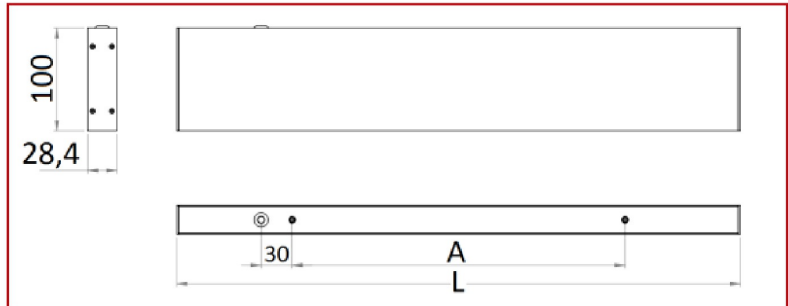
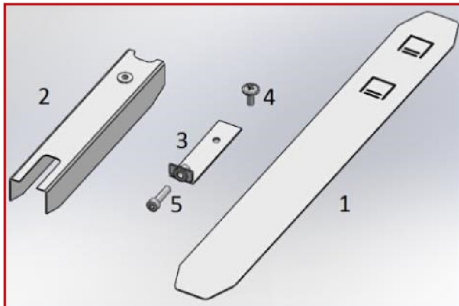