

## FICHE TECHNIQUE

## Suspension Start-S Opale DI-IN

Modèle SSSODI5DA50637B0147

Suspension Start-S Opale DI-IN 77W 3180-4850Lm H75\*L2170\*I57mm  
Suspension IP20 IK08 120° 3000K

Code GTIN : 3701481500641

Fabriqué en  
Europe

Sur commande

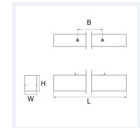
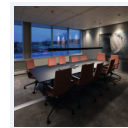
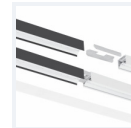
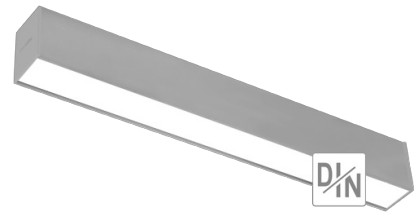
Sur-mesure  
possiblePhoto(s) non contractuelle(s).  
L'apparence du produit peut être amenée à être modifiée.

## Informations principales

Réf.	SSSODI5DA50637B0147
Marque	PIXEL Lighting
Nom produit	Suspension Start-S Opale DI-IN
Type	Éclairage intérieur
Catégorie	Suspension
Sous-catégorie	Start-S
Application(s)	Bâtiment tertiaire, Etablissement scolaire
Variante(s)	6 variantes
Coloris	Gris, Blanc, Noir
Dimensions	H75 * L2170 * I57 mm
Dimensions d'installation	-
Poids	5350g

## Normes



## Données techniques

Puissance	77 W
Flux lumineux	3180-4850 LM
Rendement	104 LM/W
Angle de diffusion	120°
Température de couleur	3000K
Type de montage	Suspension
Type de LED	SMD5630
Type de diffuseur / réflecteur	Opale
Type de driver	Helvar
Usage intensif	Oui
Température fonctionnement	-20° à +40° C

## Performances luminaire

IP 20	IK 08	120°	L80B10	72000H
***	UGR <20	220-240V	50-60HZ	5 ANS

## Caractéristiques



## En option















## Variantes

Réf.	Puissance en W	Flux lumineux en LM	Rendement en LM/W	Angle en °	Dimensions en mm	Type de montage	Température couleur en K	IP	IK	Durée de vie en H	L / B	Classe
SSSODI5DA506375CDB3	39	1590-2330	100	120°	H75 * L1085 * I57	Suspension	3000K	20	08	72000	L80B10	I
SSSODI5DA5063792BF6	39	1620-2380	102	120°	H75 * L1085 * I57	Suspension	4000K	20	08	72000	L80B10	I
SSSODI5DA506379CA59	58	2380-3610	103	120°	H75 * L1625 * I57	Suspension	3000K	20	08	72000	L80B10	I
SSSODI5DA50637A6635	58	2430-3680	105	120°	H75 * L1625 * I57	Suspension	4000K	20	08	72000	L80B10	I
SSSODI5DA50637B0147	77	3180-4850	104	120°	H75 * L2170 * I57	Suspension	3000K	20	08	72000	L80B10	I
SSSODI5DA50637C54EC	77	3240-4950	106	120°	H75 * L2170 * I57	Suspension	4000K	20	08	72000	L80B10	I

## Accessoires

Aperçu	Réf.	Nom	Description	Garantie (an)	Marque
	ACC5DC3516D15C84	Suspension Normale - Acier 1500 mm	Compatible gammes : Start - Novo - Nano - Record - Style - Initial - Micro - Ring - Geo - Linéa - Retail - Dimensions : 1500 mm x 15/12 mm	2	PIXEL Lighting
	ACC5DC3516DC3A58	Suspension Electrique - Gris Clair 1500 mm	Compatible gammes : Start - Novo - Nano - Record - Style - Initial - Micro - Ring - Geo - Retail - Alimentation électrique incluse	2	PIXEL Lighting
	ACC5DC3516ECF6B9	Suspension Electrique - Blanc 1500 mm	Compatible gammes : Start - Novo - Nano - Record - Style - Micro - Ring - Geo - Retail - Alimentation électrique incluse	2	PIXEL Lighting
	ACC5DC351707185D	Suspension Electrique - Noir 1500 mm	Compatible gammes : Start - Novo - Nano - Record - Style - Geo - Ring Alimentation électrique incluse	2	PIXEL Lighting
	ACC5DC3517A34841	Embout d'extrémité Gris Clair (unité)	Compatible gamme Start-S En aluminium : à visser	2	PIXEL Lighting
	ACC5DC3517B25DFD	Embout PC d'extrémité Blanc (unité)	Compatible gamme Start-S	2	PIXEL Lighting

Aperçu	Réf.	Nom	Description	Garantie (an)	Marque
	ACC5DC3517C05C22	Embout d'extrémité Noir (unité)	Compatible gamme Start-S En aluminium : à visser	2	PIXEL Lighting
	ACC5DC3517CE8C1F	Jonction 90° Non lumineuse	Compatible gamme Start	2	PIXEL Lighting
	ACC5DC3517DE53F6	Jonction en T Non lumineux	Compatible gamme Start	2	PIXEL Lighting
	ACC5DC3517EDCB76	Jonction Linéaire invisible	Compatible gammes : Start - Novo - Nano - Record - Trigos Fixation de 2 modules entre eux	2	PIXEL Lighting
	ACC5DCD5163AFB91	Coupleur en croix 6 branches	Compatible gamme Start	2	PIXEL Lighting
	ACC5E57F5672B4C0	Driver DALI LCA 50W 100-400mA one4all Ip PRE2	Inclus I-SELECT 2 PLUG 250mA - Durée de vie 100.000 heures	5	Tridonic
	ACC5E57F5E354378	Driver DALI LCA 75W 100-400mA one4all Ip PRE	Inclus I-SELECT 2 PLUG 350mA - Durée de vie 100.000 heures	5	Tridonic
	ACC5E5FDB8845662	Driver DALI LCA 35W 150-700mA one4all Ip PRE	Inclus I-SELECT 2 PLUG 350MA BL - Durée de vie 100 000 heures	5	Tridonic
	ACC5F4E5577C2942	Câblage traversant 5 fils - 545 mm	Compatible gamme Start	5	PIXEL Lighting
	ACC5F4E563C52140	Câblage traversant 5 fils - 1085 mm	Compatible gamme Start : linéaires et modules en L	5	PIXEL Lighting
	ACC5F4E573536F4A	Câblage traversant 5 fils - 1625 mm	Compatible gamme Start	5	PIXEL Lighting
	ACC5F4E58DF43905	Câblage traversant 5 fils - 2170 mm	Compatible gamme Start	5	PIXEL Lighting
-	ACC62B0257F6A4CC	Module non lumineux 545 mm	Câblage traversant inclus	2	PIXEL Lighting
-	ACC62B0263D0B7CC	Module non lumineux 1085 mm	Câblage traversant inclus	2	PIXEL Lighting
-	ACC62B026ED46C53	Module non lumineux 1625 mm	Câblage traversant inclus	2	PIXEL Lighting
-	ACC62B02818A1F0F	Module non lumineux 2170 mm	Câblage traversant inclus	2	PIXEL Lighting

## Schéma technique

---

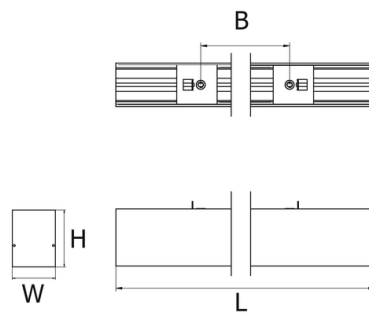

## Schéma de montage

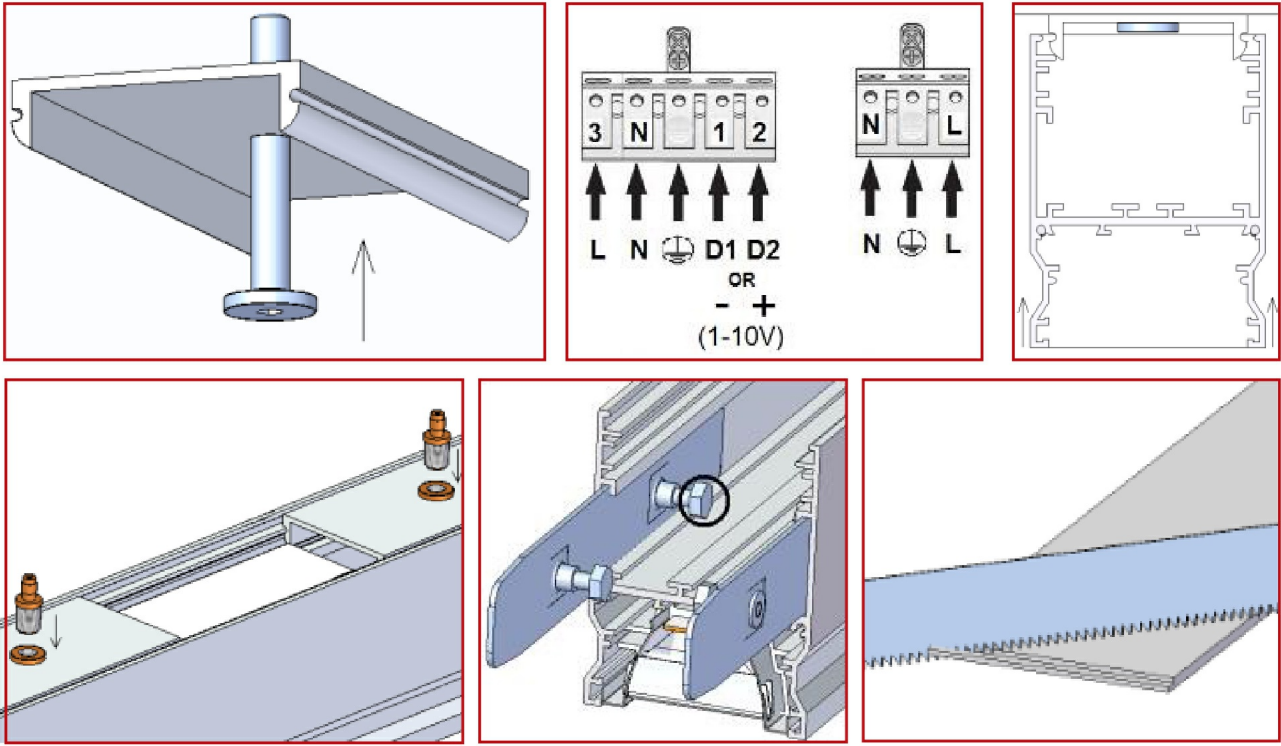

## Système de suspension rapide

